

# Intro

At TAL, design is an inseparable part of our DNA. That is why we are constantly on the lookout for new design trends and architectural needs. Lately, we've been noticing an increased demand for anodics, which is why we have decided to extend our product range with three new anodised VERSIONS: gold, titanium and bronze. In order to meet our quality standards, we have changed the alloy of our fixtures. Each and every single one of them is completely BRUSHED and fully anodised. This is the case for all of our products, even the ones that consist of different aesthetic components, such as the Berrier, since we refuse to make concessions when it comes to quality and looks.

Our new anodics range will be available from September onwards, but you can already discover them in our latest catalogue. We're sure you'll be enchanted!

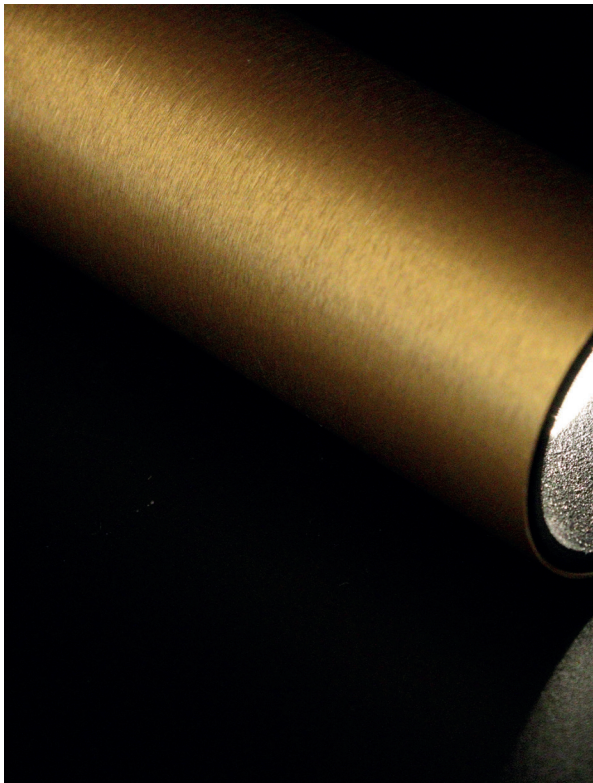
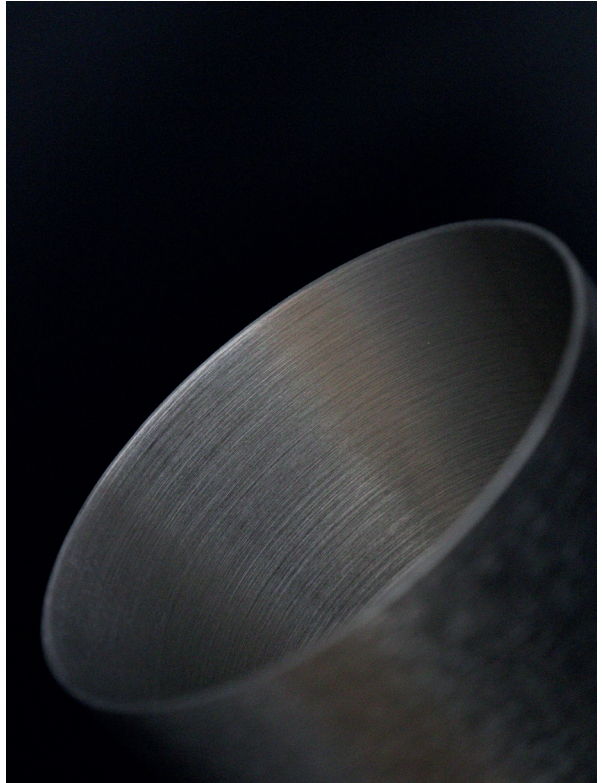

# Brushed Anodics

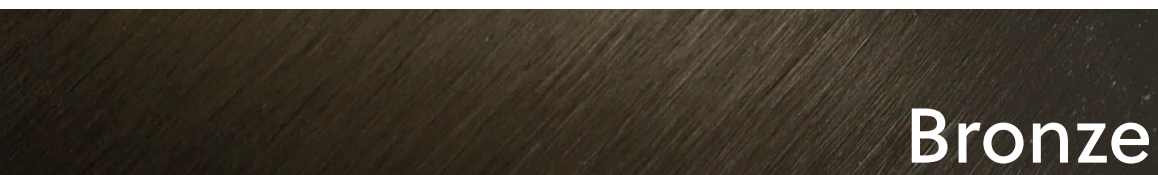
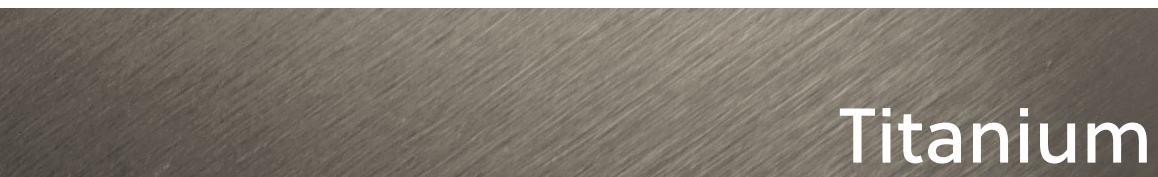
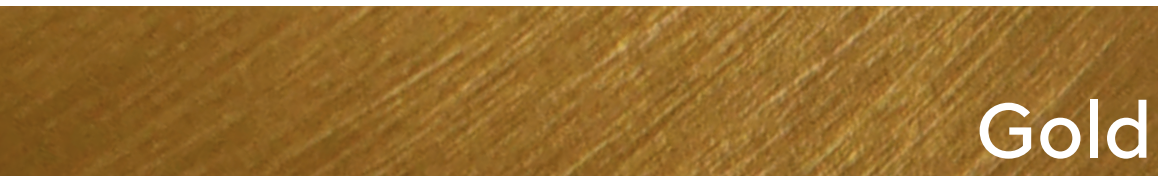

Berrier Junior Suspension CI	43	Microscop	21
Berrier Junior Suspension M10	41	Mini Helax	15
Berrier Junior Wall	35	Nobel Elbow Base CI	27
Drebbel	9	Nobel Elbow M10 WC	23
Funnel Elbow 150 CI	33	Nobel Elbow On Base Recessed	25
Funnel Elbow 150 Track 230V	51	Nobel Elbow Track 48V	45
Funnel Elbow 150 Track 48V	47	Nobel Pi CI	39
Funnel On 150 CI	31	Nobel Pi M10	37
Funnel On Splash CI	29	Nobel Sferos	17
Funnel Sferos	19	Nobel Sferos Trimless	11
Funnel Sferos Trimless	13	Track 48V	49

# Craftsmanship

---







## Drebbel

### LUXEON M - 7,84W - 700mA DC - (11,2Vf)

755 lumen 2700K CRI90

810 lumen 3000K CRI90

dimmability: PWM/CCR  
beam 36°

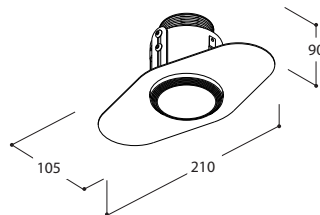

 111 mm  
Installation depth:  
105 mm hollow ceilings

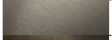
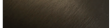
finish	2700K	3000K	€
	132614	132615	180,-
	132604	132624	180,-
	132605	132625	180,-



 Converter matrix, see pages 54-55







## Nobel Sferos Trimless

LUXEON M - 3,82W - 350mA DC - (10,95Vf)

400 lumen 2700K CRI90

429 lumen 3000K CRI90

dimmability: PWM/CCR

beam 36°

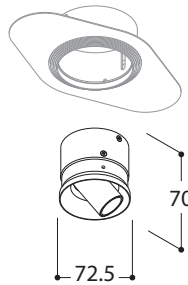

125 mm  
Installation depth 75 mm  
359° 55°

finish	focus	2700K	3000K	€
		498503	498513	280,-
		498504	498514	280,-
		498505	498515	280,-
! installation frame for plaster		701113		48,-



! Converter matrix, see pages 54-55





## Funnel Sferos Trimless

LUXEON M - 7,84W - 700mA DC - (11,2Vf)

755 lumen 2700K CRI90



810 lumen 3000K CRI90

dimmability: PWM/CCR

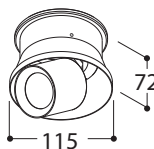
beam 24° - 36° - 60°

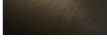

140 mm  
Installation depth 80 mm  
345° 60°

finish	2700K			3000K			€
	24°	36°	60°	24°	36°	60°	
	133843	133823	133883	133853	133833	133893	375,-
	133844	133824	133884	133854	133834	133894	375,-
	133845	133825	133885	133855	133835	133895	375,-
! installation frame for plaster				701122			100,-
! honeycomb				MX100090			10,-



! Converter matrix, see pages 54-55

Funnel Sferos Trimless





## Mini Helax

LUXEON M - 3,82W - 350mA DC - (10,95Vf)

400 lumen 2700K CRI90

429 lumen 3000K CRI90

dimmability: PWM/CCR

beam 36°

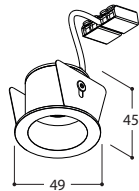

 40 mm  
Installation depth 60 mm

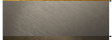
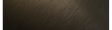
finish	2700K	3000K	€
	178903	178913	110,-
	178904	178914	110,-
	178905	178915	110,-



 Converter matrix, see pages 54-55

Mini Helax

downlights

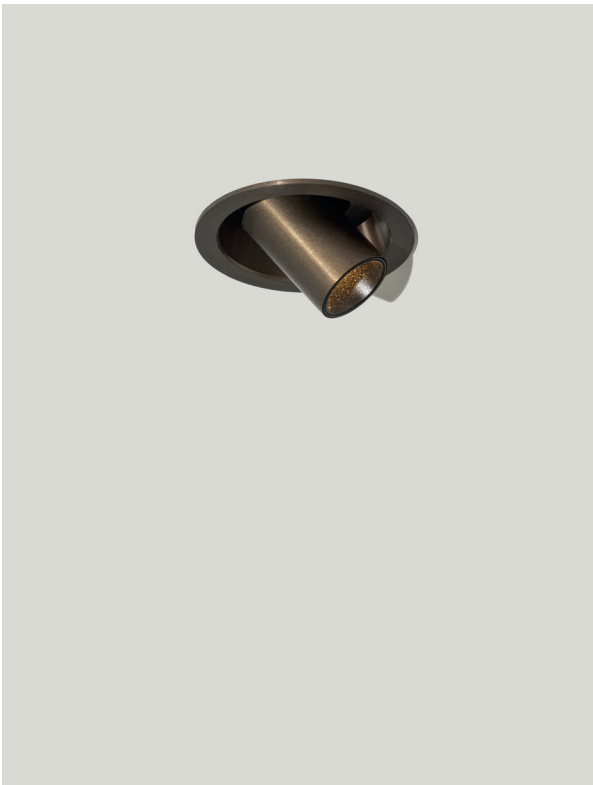

## Nobel Sferos Torsion

LUXEON M - 3,82W - 350mA DC - (10,95Vf)

400 lumen 2700K CRI90  
 429 lumen 3000K CRI90  
 dimmability: PWM/CCR  
 beam 36°

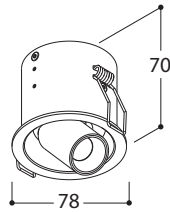

70 mm  
 Installation depth 75mm  
 359° 55°

finish	focus	2700K	3000K	€
		498103	498113	250,-
		498104	498114	250,-
		498105	498115	250,-
+ Frame for plaster		498100		13,-

## Nobel Sferos Leaf

LUXEON M - 3,82W - 350mA DC - (10,95Vf)

400 lumen 2700K CRI90  
 429 lumen 3000K CRI90  
 dimmability: PWM/CCR  
 beam 36°

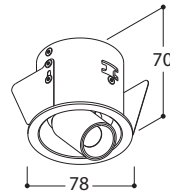

70 mm  
 Installation depth 75mm for hollow ceilings  
 90mm for solid ceilings  
 359° 55°

finish	focus	2700K	3000K	€
		498403	498413	250,-
		498404	498414	250,-
		498405	498415	250,-
+ Frame for plaster		498100		13,-



Converter matrix, see pages 54-55



downlights



## Funnel Sferos Torsion

LUXEON M - 7,84W - 700mA DC - (11,2Vf)

755 lumen 2700K CRI90

810 lumen 3000K CRI90

dimmability: PWM/CCR

beam 24° - 36° - 60°

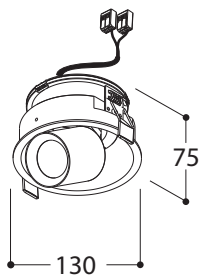

125 mm  
Installation depth 80 mm  
345° 60°

finish	2700K			3000K			€
	24°	36°	60°	24°	36°	60°	
	134103	134123	134143	134113	134133	134153	480,-
	134104	134124	134144	134114	134134	134154	480,-
	134105	134125	134145	134115	134135	134155	480,-
	honeycomb			MX100090			10,-

## Funnel Sferos Leaf

LUXEON M - 7,84W - 700mA DC - (11,2Vf)

755 lumen 2700K CRI90

810 lumen 3000K CRI90

dimmability: PWM/CCR

beam 24° - 36° - 60°

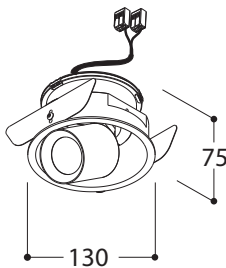

125 mm  
Installation depth 80 mm  
345° 60°

finish	2700K			3000K			€
	24°	36°	60°	24°	36°	60°	
	134203	134223	134243	134213	134233	134253	480,-
	134204	134224	134244	134214	134234	134254	480,-
	134205	134225	134245	134215	134235	134255	480,-
	honeycomb			MX100090			10,-



Converter matrix, see pages 54-55

surface mounted



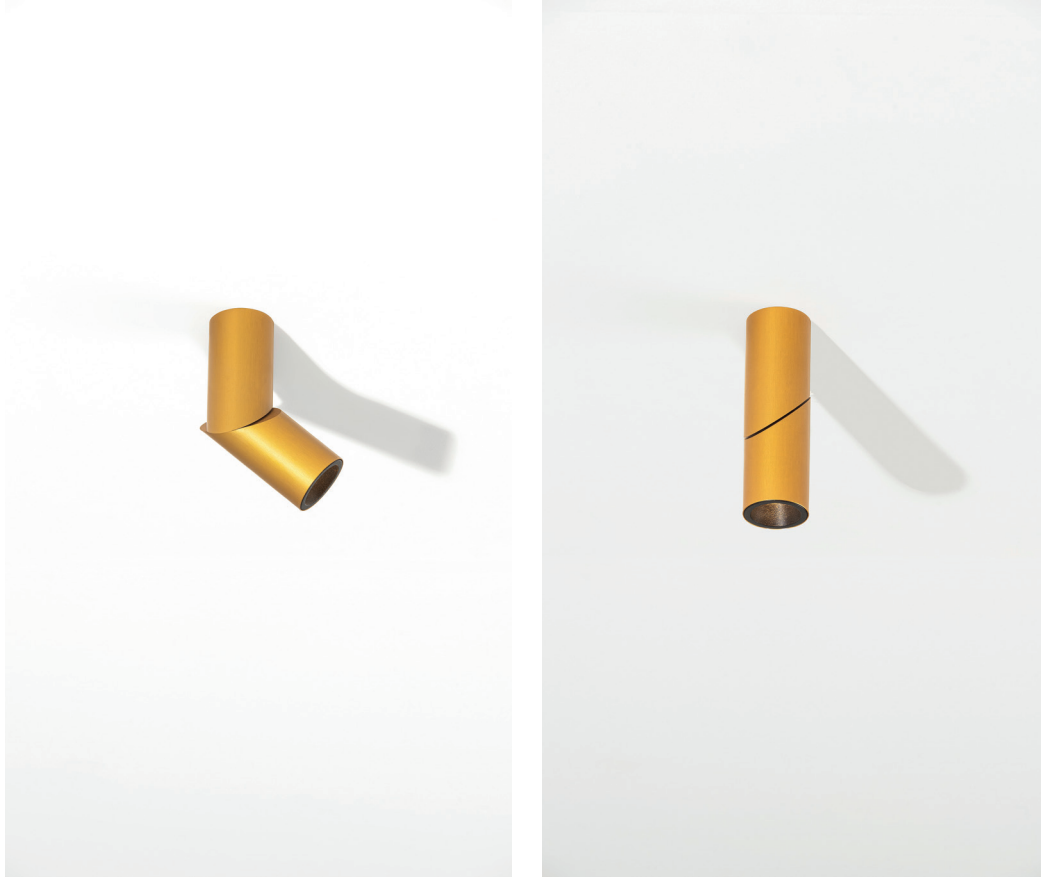

## Microscop

LUXEON M - 3,82W - 350mA DC - (10,95Vf)

400 lumen 2700K CRI90

429 lumen 3000K CRI90

dimmability: PWM/CCR

beam 36°

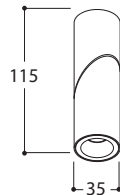

↻ 359° ↻ 359°

finish	focus	2700K	3000K	€
		407013	407213	220,-
		407014	407214	220,-
		407015	407215	220,-
	Microscop Wall Adapter black	407926		46,-
	Microscop Wall Adapter white	407947		46,-



Converter matrix, see pages 54-55

surface mounted





## Nobel Elbow M10 WC

LUXEON M - 3,82W - 350mA DC - (10,95Vf)

400 lumen 2700K CRI90





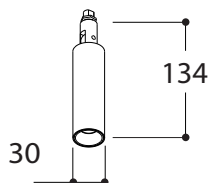

429 lumen 3000K CRI90

dimmability: PWM/CCR

beam 36°

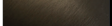

↻ 315° ↻ 90°

finish	focus	2700K	3000K	€
		459803	459813	140,-
		459804	459814	140,-
		459805	459815	140,-

📌 Possible on Ringo, M10 bases and Profiles

Check our main catalogue or website.



📌 Converter matrix, see pages 54-55

Nobel Elbow M10 WC

surface mounted





## Nobel Elbow WC

LUXEON M - 3,82W - 350mA DC - (10,95Vf)



400 lumen 2700K CRI90





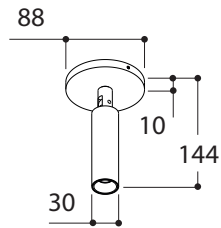

429 lumen 3000K CRI90

dimmability: PWM/CCR

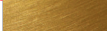

beam 36°

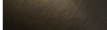

 42mm  
 Installation depth 40 mm  
 315°  90°

finish	focus	2700K	3000K	€
		459403	459413	225,-
		459404	459414	225,-
		459405	459415	225,-

 Fits on standard round electrical accessory box with screws.

 Hole 68mm  
 Installation depth 61mm



 Converter matrix, see pages 54-55



surface mounted





## Nobel Elbow Base CI

LUXEON M - 3,82W - 230V 50-60HZ AC

400 lumen 2700K CRI90

429 lumen 3000K CRI90

dimmability: mains dimm LC

beam 36°

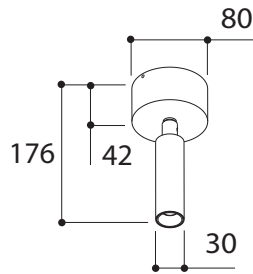

↻ 315° ↻ 90°

finish	focus	2700K	3000K	€
		459203	459213	250,-
		459204	459214	250,-
		459205	459215	250,-



Nobel Elbow WC

surface mounted





## Funnel On Splash

LUXEON M - 3,82W - 230V 50-60HZ AC





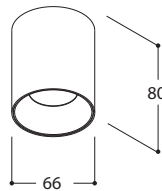

400 lumen 2700K CRI90

429 lumen 3000K CRI90

dimmability: mains dimm LC

beam 36°

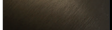

finish	focus	2700K	3000K	€
		433903	433913	275,-
		433904	433914	275,-
		433905	433915	275,-



Funnel On Splash

surface mounted





## Funnel On 150 CI





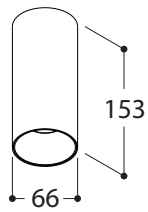

LUXEON M - 7,84W - 230V 50-60HZ AC

755 lumen 2700K CRI90

810 lumen 3000K CRI90

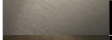
dimmability: mains dimm LC  
beam 36°

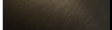

finish	focus	2700K	3000K	€
		479403	479413	242,-
		479404	479414	242,-
		479405	479415	242,-



Funnel On 150 CI

surface mounted





## Funnel Elbow 150 CI





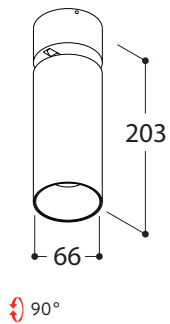

LUXEON M - 7,84W - 230V 50-60HZ AC

755 lumen 2700K CRI90

810 lumen 3000K CRI90

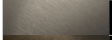
dimmability: mains dimm LC  
beam 36°

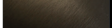

finish	focus	2700K	3000K	€
		479603	479613	393,-
		479604	479614	393,-
		479605	479615	393,-



Funnel Elbow 150 CI



wall mounted

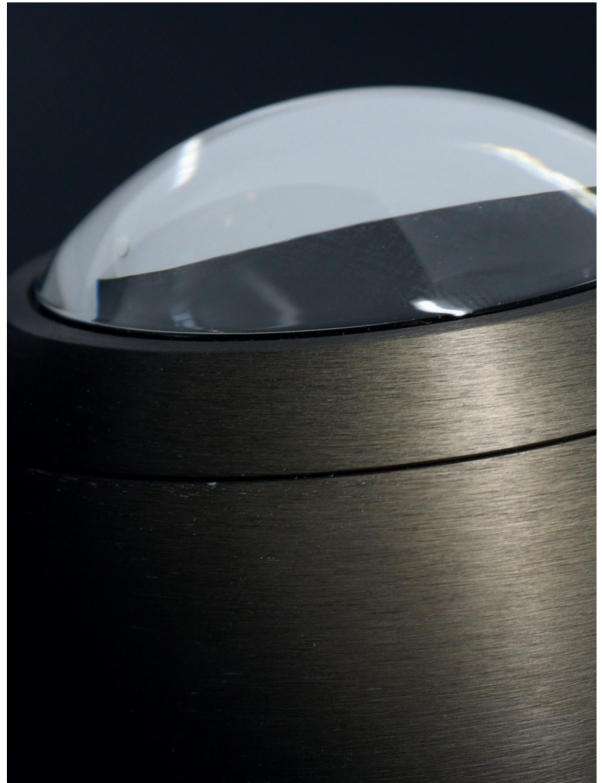
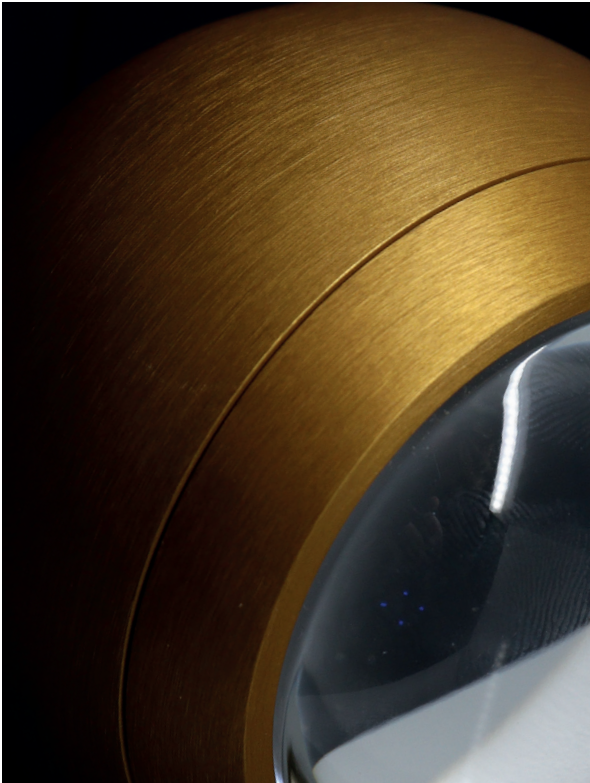
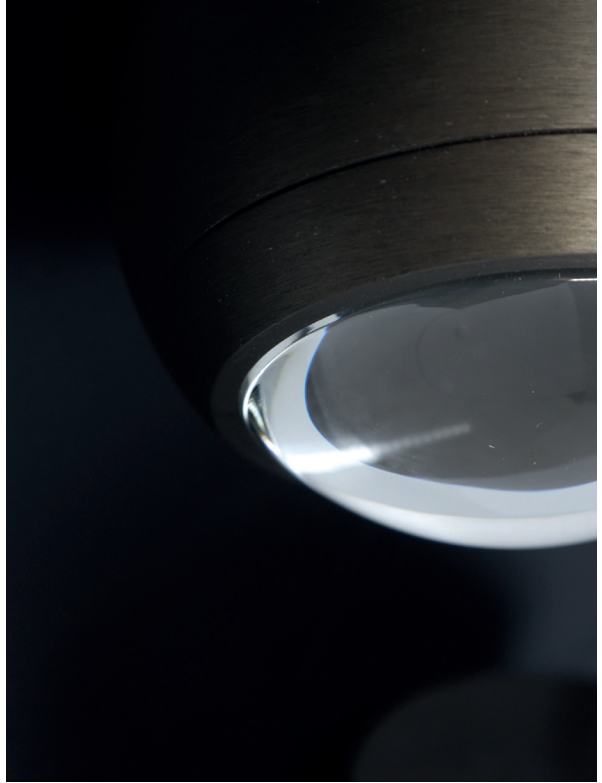
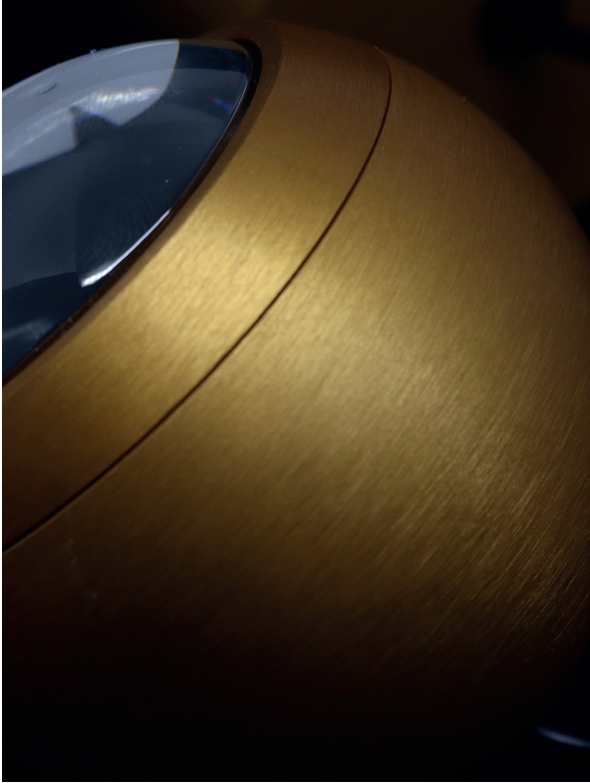



## Berrier Junior Wall

LUXEON M - 3,82W - 350mA DC - (10,95Vf)

400 lumen 2700K CRI90



429 lumen 3000K CRI90

dimmability: PWM/CCR

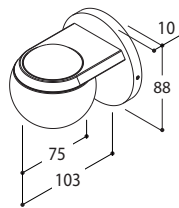
beam 60°

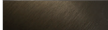

 42mm  
Installation depth 50 mm

finish	2700K	3000K	€
	456763	456773	385,-
	456764	456774	385,-
	456765	456775	385,-

 Fits on standard round electrical accessory box with screws.

 Hole 68mm  
Installation depth 61mm



 Converter matrix, see pages 54-55

Berrier Junior Wall



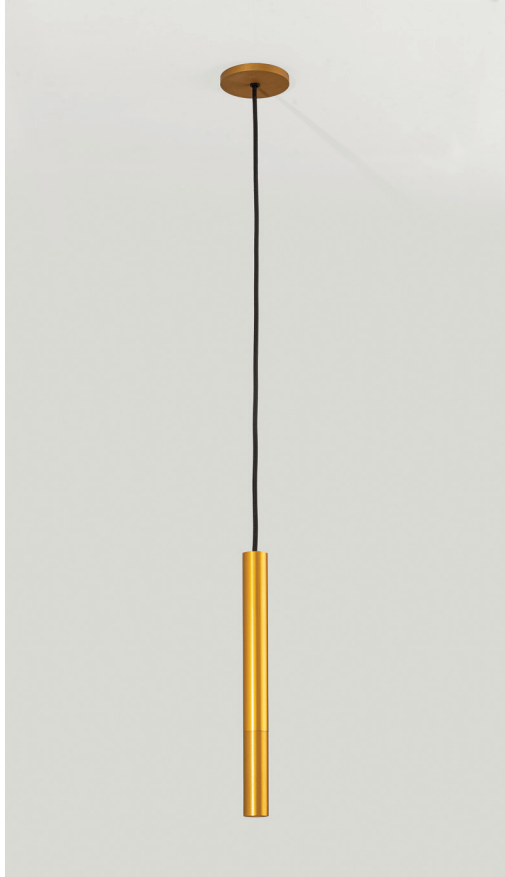

## Nobel PI M10 WC

LUXEON M - 3,82W - 350mA DC - (10,95Vf)

400 lumen 2700K CRI90

429 lumen 3000K CRI90

dimmability: PWM/CCR

beam 36°

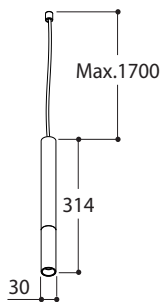

finish	focus	2700K	3000K	€
		418243	418253	215,-
		418244	418254	215,-
		418245	418255	215,-

## M10 Base Recessed Large

350mA DC

⚠ Can be used as access point for converter

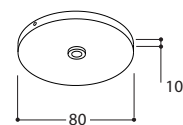

⚙ 42mm

Installation depth 50 mm or

Hole 68mm

Installation depth 61mm

finish	M10 BASE	€
	408913	66,-
	408914	66,-
	408915	66,-

ⓘ For other M10 bases or profile systems check our main catalogue or website.



ⓘ Converter matrix, see pages 54-55





## Nobel PI CI

LUXEON M - 3,82W - 230V 50-60HZ AC

400 lumen 2700K CRI90

429 lumen 3000K CRI90

dimmability: mains dimm LC

beam 36°

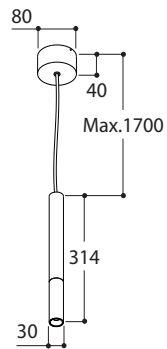

finish	focus	2700K	3000K	€
		418403	418413	280,-
		418404	418414	280,-
		418405	418415	280,-



Nobel PI CI



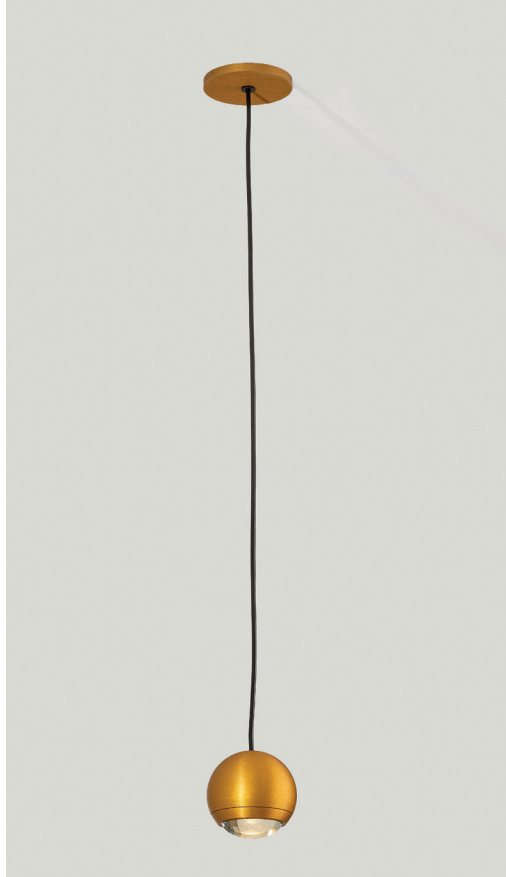

## Berrier Junior Suspension M10 WC

LUXEON M - 3,82W - 350mA DC - (10,95Vf)

400 lumen 2700K CRI90

429 lumen 3000K CRI90

dimmability: PWM/CCR

beam 60°

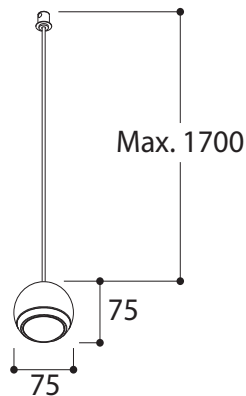

finish	2700K	3000K	€
	456163	456173	266,-
	456164	456174	266,-
	456165	456175	266,-

## M10 Base Recessed Large

350mA DC

⚠ Can be used as access point for converter

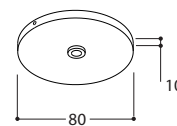

⚠ 42mm  
Installation depth 50 mm or  
Hole 68mm  
⚠ 61mm  
Installation depth 61mm

finish	M10 BASE	€
	408913	66,-
	408914	66,-
	408915	66,-

ⓘ For other M10 bases or profile systems check our main catalogue or website.

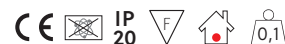

ⓘ Converter matrix, see pages 54-55







## Berrier Junior Suspension CI

LUXEON M - 3,82W - 230V 50-60HZ AC



400 lumen 2700K CRI90

429 lumen 3000K CRI90

dimmability: mains dimm LC

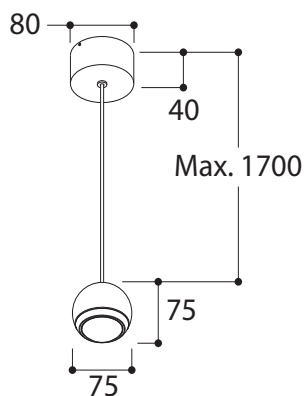
beam 60°

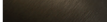

finish	2700K	3000K	€
	456063	456073	330,-
	456064	456074	330,-
	456065	456075	330,-



Berrier Junior Suspension CI







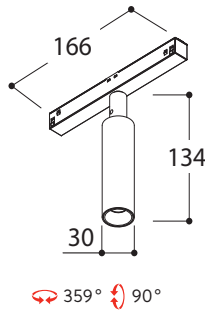

## Nobel Elbow Track 48V

LUXEON M - 3,82W  
 400 lumen 2700K CRI90  
 429 lumen 3000K CRI90  
 beam 36°

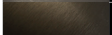

finish	focus	2700K	3000K	€	2700K DALI	3000K DALI	€
		459603	459613	270,-	459663	459673	300,-
		459604	459614	270,-	459664	459674	300,-
		459605	459615	270,-	459665	459675	300,-

See page 49 for 48V tracks



Converter matrix, see pages 54-55

48V track



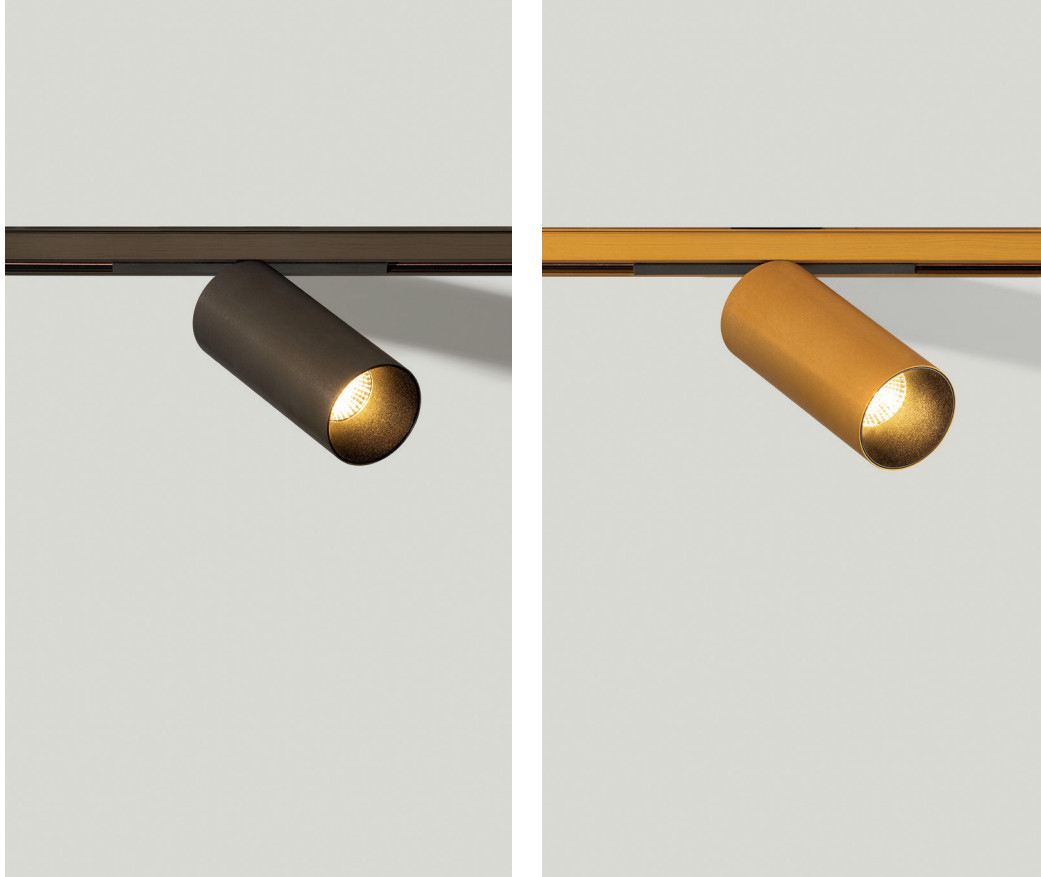

## Funnel Elbow 150 Track 48V

### LUXEON M - 7,84W

755 lumen 2700K CRI90  
 810 lumen 3000K CRI90  
 beam 36°

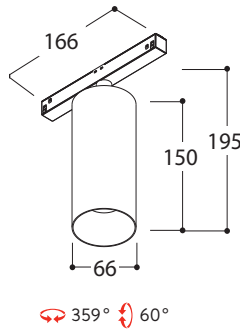

finish	focus	2700K	3000K	€	2700K DALI	3000K DALI	€
		484903	484993	315,-	484803	484893	345,-
		484904	484994	315,-	484804	484894	345,-
		484905	484995	315,-	484805	484895	345,-

📌 See page 49 for 48V tracks





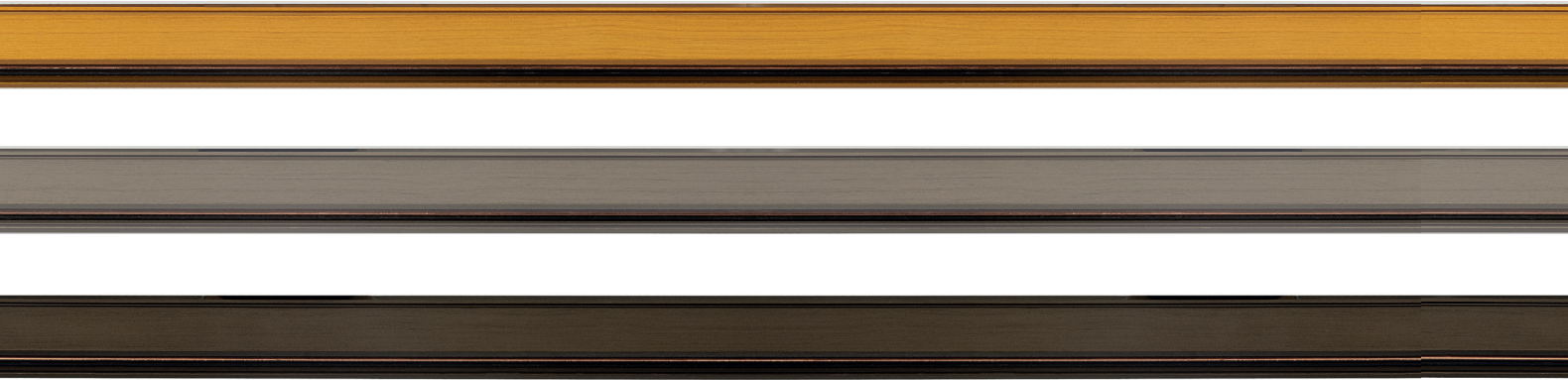

📌 Converter matrix, see pages 54-55

48V track

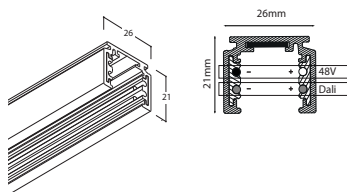

## Track 48V Surface or Suspended

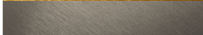

finish	1000MM	€	2000MM	€	3000MM	€
	TR4113	115,-	TR4213	218,-	TR4313	320,-
	TR4114	115,-	TR4214	218,-	TR4314	320,-
	TR4115	115,-	TR4215	218,-	TR4315	320,-

 All accessories in either black or white can be found in our main catalogue or website.



 Converter matrix, see pages 54-55







## Funnel Elbow 150 Ci Track 230V

LUXEON M - 7,84W - 230V 50-60HZ AC

755 lumen 2700K CRI90





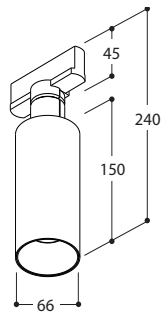

810 lumen 3000K CRI90

dimmability: mains dimm LC

beam 36°

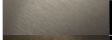

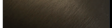
↻ 359° ↻ 90°

finish	focus	2700K	3000K	€
		477603	477613	350,-
		477604	477614	350,-
		477605	477615	350,-



Funnel Elbow 150 Ci Track 230V

# How to use

Lamp type - power - supply

Product name

## Mini Tommy 1 Haloled

LUXEON M - 7,84W - 700mA DC - (11,2 Vf)

Light output

- 755 lumen 2700K CRI90
- 810 lumen 3000K CRI90

Dim protocol

- dimmiability: PWM/CCR

Beam angle

- beam 36°

Product dimensions

Cut out dimensions + Installation depth

- 110 x 110 mm
- Installation depth 135 mm

Adjustability

- 30°

Color temperature (for LED only)

finish	2700K		3000K	
Beam angle	35°	70°	35°	70°
Finish of the product	123456	123456	123456	123456
	123456	123456	123456	123456

Reference number

Obligatory accessories to be ordered separately

- Installation frame for plaster 123456

Optional accessories to be ordered separately

- +

Cut out dimensions

- 200 x 235 mm

Family members:

Same product to be found in different product categories

European conformity

Energy class

Product weight

Indoor/outdoor use

Flammability index

Gear type

IP rate

Electrical class

4000K product on demand



# Finishes

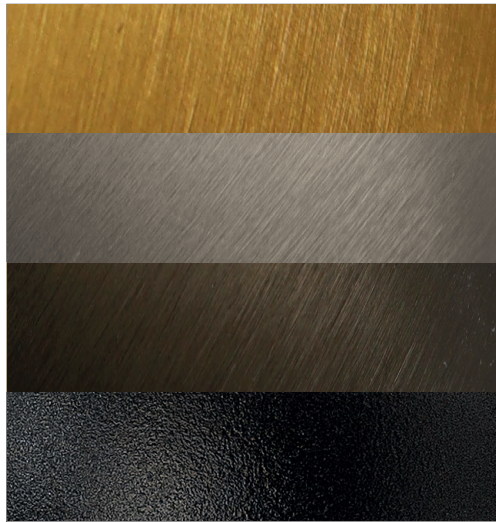

Brushed Gold Ano

Brushed Titanium Ano

Brushed Bronze Ano

Textured Black

# Properties

## APPLICATION



Interior use



Normally flammable surface



IP rating



Obligatory accessory



Optional accessory



Conformance EU



Rotation



Tilt



Gimble



Cut out round



Cut out round



$135 \leq TM < 160$



$110 \leq TM < 135$



$85 \leq TM < 110$



$TM < 85$



Weight



Class 1



Class 2



Class 3



Electronical gear included



Mains voltage



Electronical gear required



Dimmable with trailing edge dimmer



Dimmable with universal dimmer



Dimmable with leading edge dimmer



Dimmable with standard dimmer



Pulse width modulation

TYPE	ARTNR	DESCRIPTION	STRAIN RELIEF	LOCATION	DIMMABILITY	CCR (AMPLITUDE)	SIZE: L*B*H (mm)	EFFICIENCY	IP	CLASS	INPUT VOLTAGE (V)	OUTPUT VOLTAGE (V)	LED power 9
24V DC	40025	LED CONVERTER 24V 10W IP20	NO	INDOOR	NOT DIMMABLE	-	76*36*18	60%	20	2	198 - 254	24	1
24V DC	40057	LED CONVERTER REMOTE 24V 20W IP20	YES	INDOOR	NOT DIMMABLE	-	109*50*35	83%	20	2	195 - 254	24	2
24V DC	40063	LED CONVERTER 24V 20W IP67	NO	IN&OUTDOOR	NOT DIMMABLE	-	118*35*26	83%	67	2	90 - 264	24	2
24V DC	40080	LED CONVERTER REMOTE 24V 20W IP20 1-10V	YES	INDOOR	1-10V	-	103*67*21	88%	20	2	100 - 264	24	2
24V DC	40070	LED CONVERTER 24V 35W IP67	NO	IN&OUTDOOR	NOT DIMMABLE	-	148*40*30	85%	67	2	90 - 264	24	2
24V DC	40081	LED CONVERTER 24V 40W IP67 1-10V	NO	IN&OUTDOOR	1-10V	-	162,5*43*32	87%	67	2	90 - 305	24	2
24V DC	40087	LED CONVERTER REMOTE 24V 50W IP20 DALI/TOUCHDIM	YES	INDOOR	DALI/TOUCHDIM	-	346*32*22	90%	20	2	198 - 264	24	5
24V DC	40071	LED CONVERTER 24V 60W IP67	NO	IN&OUTDOOR	NOT DIMMABLE	-	162,5*42,5*32	86%	67	2	90 - 264	24	6
24V DC	40082	LED CONVERTER 24V 60W IP20 1-10V	NO	IN&OUTDOOR	1-10V	-	162,5*43*32	89%	67	2	90 - 305	24	6
24V DC	40088	LED CONVERTER REMOTE 24V 80W IP20 DALI/TOUCHDIM	YES	INDOOR	DALI/TOUCHDIM	-	346*32*22	90%	20	2	198 - 264	24	8
24V DC	40083	LED CONVERTER 24V 90W IP67 1-10V	NO	IN&OUTDOOR	1-10V	-	161*61*36	90%	67	2	90 - 305	24	9
24V DC	40072	LED CONVERTER 24V 100W IP67	NO	IN&OUTDOOR	NOT DIMMABLE	-	262*66*42	92%	67	2	220 - 240	24	10
24V DC	40084	LED CONVERTER 24V 120W IP67 1-10V	NO	IN&OUTDOOR	1-10V	-	220*68*38,8	93%	67	1	90 - 305	24	12
24V DC	40073	LED CONVERTER 24V 150W IP67	NO	IN&OUTDOOR	NOT DIMMABLE	-	211*66*42	92%	67	2	220 - 240	24	15
48V	40067	LED CONVERTER 48V 70W IP20	YES	INDOOR	NOT DIMMABLE	-	210*60*36	91%	20	1	220 - 240	48	1
48V	40049	LED CONVERTER DINRAIL 48V 150W IP20	NO	INDOOR	NOT DIMMABLE	-	105*90*59	90%	20	2	85 - 264	48	1
180mA	930544	POWERLED CONVERTER REMOTE 180mA 7,2W IP20 MAINS DIM C	YES	INDOOR	MAINS DIM C	NO	99*39*23	80%	20	2	230 - 240	20 - 40	1
180mA	930546	POWERLED CONVERTER REMOTE 180mA 8W IP20 1-10V	YES	INDOOR	1-10V	YES	110*52*23,5	85%	20	2	110 - 240	6 - 42	1
180mA	930565	POWERLED CONVERTER REMOTE 180mA 10W IP20 MAINS DIM LC/1-10V	YES	INDOOR	MAINS DIM LC 10%/1-10V	YES	101,5*51*29,5	77%	20	2	220 - 240	28 - 56	1
180mA	930545	POWERLED CONVERTER REMOTE 180mA 15W IP20	YES	INDOOR	NOT DIMMABLE	-	115*34*19	58%	20	2	90 - 264	0 - 41,5	1
180mA	930588	POWERLED CONVERTER REMOTE 180mA 15W IP20 DALI/TOUCHDIM	YES	INDOOR	DALI/TOUCHDIM	YES	119*53*30	88%	20	2	198 - 264	20 - 54	1
180mA	930605	POWERLED CONVERTER REMOTE 180mA 18W IP20 MAINS DIM LC	YES	INDOOR	MAINS DIM LC	YES	120*45*28	87%	20	2	220 - 240	52 - 103	1
180mA	930606	POWERLED CONVERTER REMOTE 180mA 9W IP20 CASAMBI	YES	INDOOR	CASAMBI	YES	200*43*30	82%	20	2	198 - 264	15 - 40	1
250mA	930598	POWERLED CONVERTER 250mA 5W IP65 MAINS DIM LC	NO	IN&OUTDOOR	MAINS DIM LC	YES	38*27*21	73%	65	2	220 - 240	12 - 24	1
260mA	930603	POWERLED CONVERTER 260mA 12W IP65 MAINS DIM LC	NO	IN&OUTDOOR	MAINS DIM LC	YES	48*50*24	83%	65	2	220 - 240	23 - 46	1
260mA	930599	POWERLED CONVERTER REMOTE 260mA 12W IP20 1-10V	YES	INDOOR	1-10V	YES	110*52*23,5	88%	20	2	220 - 240	6 - 42	1
250mA	930601	POWERLED CONVERTER REMOTE 250mA 13,5W IP20 DALI/TOUCHDIM	YES	INDOOR	DALI/TOUCHDIM	YES	119*53*30	88%	20	2	198 - 264	12 - 54	1
260mA	930604	POWERLED CONVERTER REMOTE 260mA 20W IP20 MAINS DIM LC	YES	INDOOR	MAINS DIM LC	YES	120*45*28	85%	20	2	220 - 240	38 - 77	1
250mA	930607	POWERLED CONVERTER REMOTE 250mA 10W IP20 CASAMBI	YES	INDOOR	CASAMBI	YES	200*43*30	82%	20	2	198 - 264	15 - 40	1
350mA	930512	POWERLED CONVERTER 350mA 4W IP65 MAINS DIM LC	NO	IN&OUTDOOR	MAINS DIM LC	YES	38*27*21	72%	65	2	220 - 240	6 - 12	1
350mA	930591	POWERLED CONVERTER REMOTE 350mA 6W IP20 1-10V	YES	INDOOR	1-10V	NO	67*57*22	76%	20	2	198 - 264	2 - 18	1
350mA	930573	POWERLED CONVERTER 350mA 8W IP54	NO	IN&OUTDOOR	NOT DIMMABLE	-	54*32*21	77%	54	2	90 - 264	2 - 23	1
350mA	930541	POWERLED CONVERTER 350mA 9W IP20	NO	INDOOR	NOT DIMMABLE	-	65*30,7*21,5	78%	20	2	220 - 240	3 - 25	1
350mA	930595	POWERLED CONVERTER 350mA 12W IP65 MAINS DIM LC	NO	IN&OUTDOOR	MAINS DIM LC	YES	48*50*24	82%	65	2	220 - 240	18 - 35	1
350mA	930561	POWERLED CONVERTER REMOTE 350/700mA 12W IP20 MAINS DIM C	YES	INDOOR	MAINS DIM C	NO	99*39*23	70%	20	2	230 - 240	3 - 32	1
350mA	930562	POWERLED CONVERTER REMOTE 350mA 13,5W IP20 MAINS DIM LC	YES	INDOOR	MAINS DIM LC 10%	YES	109*53*25	84%	20	2	198 - 264	18 - 38	1
350mA	930560	POWERLED CONVERTER REMOTE 350mA 15W IP20 1-10V	YES	INDOOR	1-10V	YES	110*52*23,5	88%	20	2	220 - 240	6 - 42	1
350mA	930581	POWERLED CONVERTER REMOTE 350mA 15W IP20 DALI/TOUCHDIM	YES	INDOOR	DALI/TOUCHDIM	YES	119*53*30	88%	20	2	198 - 264	9 - 51	1
350mA	930511	POWERLED CONVERTER REMOTE 350mA 18W IP20 MAINS DIM LC	YES	INDOOR	MAINS DIM LC 10%	YES	109*53*33	84%	20	2	198 - 264	27 - 54	1
350mA	930622	POWERLED CONVERTER REMOTE 18W 350mA MAINS DIM LC	YES	INDOOR	MAINS DIM LC	YES	119*53*30	84%	20	2	198 - 264	27 - 54	1
350mA	930537	POWERLED CONVERTER 350mA 26W IP66	NO	IN&OUTDOOR	NOT DIMMABLE	-	80*78*28	86%	66	2	100 - 240	38 - 75	1
350mA	930536	POWERLED CONVERTER 350mA 26W IP66 1-10V	NO	IN&OUTDOOR	1-10V	NO	80*78*28	86%	66	2	100 - 240	38 - 75	1
350mA	930608	POWERLED CONVERTER REMOTE 350mA 19W IP20 CASAMBI	YES	INDOOR	CASAMBI	YES	147*44*30	90%	20	2	198 - 264	10 - 54	1
500mA	930620	POWERLED CONVERTER 500mA 6,5W IP20 MAINS DIM RC	NO	IN&OUTDOOR	MAINS DIM RC	YES	DIA 43X25	72%	20	2	220 - 240	9-13	1
500mA	930596	POWERLED CONVERTER 500mA 12W IP65 MAINS DIM LC	NO	IN&OUTDOOR	MAINS DIM LC	YES	DIA 56X25	82%	65	2	220 - 240	12 - 24	1
500mA	930559	POWERLED CONVERTER REMOTE 500mA 16W IP20 MAINS DIM LC	YES	INDOOR	MAINS DIM LC 10%	YES	109*53*33	84%	20	2	198 - 264	18 - 36	1
500mA	930602	POWERLED CONVERTER REMOTE 500mA 21W IP20 MAINS DIM LC	YES	INDOOR	MAINS DIM LC	YES	110*52*22	89%	20	2	220 - 240	16 - 42	1
500mA	930553	POWERLED CONVERTER REMOTE 500mA 22W IP20 1-10V	YES	INDOOR	1-10V	YES	110*52*23,5	88%	20	2	220 - 240	6 - 42	1
500mA	930585	POWERLED CONVERTER REMOTE 500mA 35W IP20 DALI/TOUCHDIM	YES	INDOOR	DALI/TOUCHDIM	YES	138*67*29,5	86%	20	2	198 - 264	30 - 54	1
500mA	930556	POWERLED CONVERTER REMOTE 500mA 2x 20W IP20 1-10V	YES	INDOOR	1-10V	NO	124*79*22	89%	20	2	110 - 240	1 - 100	1
500mA	930557	POWERLED CONVERTER REMOTE 500mA 2x 20W IP20 DALI/TOUCHDIM/1-10V	YES	INDOOR	DALI/TOUCHDIM/1-10V	NO	124*79*22	89%	20	2	110 - 240	2 - 100	1
500mA	930609	POWERLED CONVERTER REMOTE 500mA 27W IP20 CASAMBI	YES	INDOOR	CASAMBI	YES	147*44*30	90%	20	2	198 - 264	10 - 54	1
700mA	930592	POWERLED CONVERTER REMOTE 700mA 10W IP20 MAINS DIM LC	YES	INDOOR	MAINS DIM LC	YES	119*53*25	79%	20	2	198 - 264	7 - 14	1
700mA	930594	POWERLED CONVERTER 700mA 12W IP65 MAINS DIM LC	NO	IN&OUTDOOR	MAINS DIM LC	YES	48*50*24	80%	65	2	220 - 240	9 - 18	1
700mA	930561	POWERLED CONVERTER REMOTE 350/700mA 12W IP20 MAINS DIM C	YES	INDOOR	MAINS DIM C	NO	99*39*23	70%	20	2	230 - 240	3 - 17	1
700mA	930587	POWERLED CONVERTER REMOTE 700mA 15W IP20 DALI/TOUCHDIM	YES	INDOOR	DALI/TOUCHDIM	YES	119*53*30	88%	20	2	198 - 264	7,5 - 26	1
700mA	930589	POWERLED CONVERTER REMOTE 700mA 25W IP20 MAINS DIM LC	YES	INDOOR	MAINS DIM LC	YES	145*51*29,5	83%	20	2	198 - 264	16 - 35	1
700mA	930578	POWERLED CONVERTER REMOTE 700mA 30W IP20 1-10V	YES	INDOOR	1-10V	YES	110*52*23,5	88%	20	2	220 - 240	6 - 42	1
700mA	930590	POWERLED CONVERTER REMOTE 700mA 35W IP20 MAINS DIM LC	YES	INDOOR	MAINS DIM LC	YES	153*54*36	87%	20	2	195 - 264	27 - 50	1
700mA	930621	POWERLED CONVERTER REMOTE 30W 700mA MAINS DIM LC	YES	INDOOR	MAINS DIM LC	YES	119*53*30	84%	20	2	198 - 264	27 - 40	1
700mA	930582	POWERLED CONVERTER REMOTE 700mA 35W IP20 DALI/TOUCHDIM	YES	INDOOR	DALI/TOUCHDIM	YES	138*67*29,5	86%	20	2	198 - 264	22 - 54	1
700mA	930618	POWERLED CONVERTER REMOTE 700mA 36W IP20 CASAMBI	YES	INDOOR	CASAMBI	YES	147*44*30	90%	20	2	198 - 264	10 - 51	1



Find lighting inspiration  
on @tal\_lighting 

**All rights reserved (09-2023)**

The information in this catalogue is provided without liability.  
All TAL products are supplied without lamps.  
TAL reserves the right to change materials, characteristics and dimensions without prior notice.  
Read all instructions carefully. TAL general conditions of sale apply.  
Nothing in this catalogue may be reproduced without written permission from TAL.

Concept & Creation: Tal nv  
Photography: toope.be